



S I S T E M A
ASTRAL 1.7
VENTANA CORREDIZA



vitral.com.co/folletos



VENTANA CORREDIZA

- Ventana Corrediza Astral I.7, que consta de naves enmarcadas, que se desplazan en forma suave, silenciosa y sin movimientos laterales sobre una guía angulada ampliando la superficie de contacto con el rodamiento.
- Tipologías posibles: OX, XO, XOX 1/3, XOX 1/4, OXXO, OXX, XX, XXO, XXX.
- Altura máxima recomendada de 1.8 metros (consultar tablas de restricciones).
- Garantizada para 10.000 ciclos de operación, con los rodamientos especificados por VITRAL.
- Posibilidad de usar cristales con espesores de 4, 5, 6 mm. monolíticos o laminados.
- Las alternativas de los entrecierres, hace que este sistema se use correctamente en diferentes tamaños y alturas en las edificaciones.
- Sellamientos dobles en felpa de alta densidad, entre el riel superior del marco y naves y entre el entrecierre y las guías inferiores, ubicados hacia el exterior para lograr una mejor insonorización, estanqueidad y protección contra filtraciones de viento y polvo.
- El sillar tiene una inclinación de 10 grados para garantizar la evacuación de líquidos.
- Posibilidad de usar alfajía integrada en el sillar según las especificaciones del diseño.
- Los horizontales del marco están diseñados para ensamblar otras guías, que sirven para adicionar el sistema de anejo.
- El diseño del sillar de una sola guía, permite el uso de un horizontal inferior fijado al sillar que no requiere el uso de rodamientos con una mayor estanqueidad, resistencia, y estructura de la ventana.

RESULTADO: TEST AEV 20-002

JUNIO 22: 2020 – FAPIM, ITALIA

MEDIDAS: (axh) 1.500 x 1.700 mm.

AREA: 2.55 m²

TIPOLOGÍA: VC 1.7 - OX

DESCRIPCIÓN DE LAS PRUEBAS	CLASE	ESTANDAR EUROPEO
PERMEABILIDAD AL AIRE	2	UNI EN 1026 - UNI EN 12207
ESTANQUEIDAD	0	UNI EN 1027 - UNI EN 12208
RESISTENCIA A LA CARGA DEL VIENTO	W1B	UNI EN 12211 - UNI EN 12210

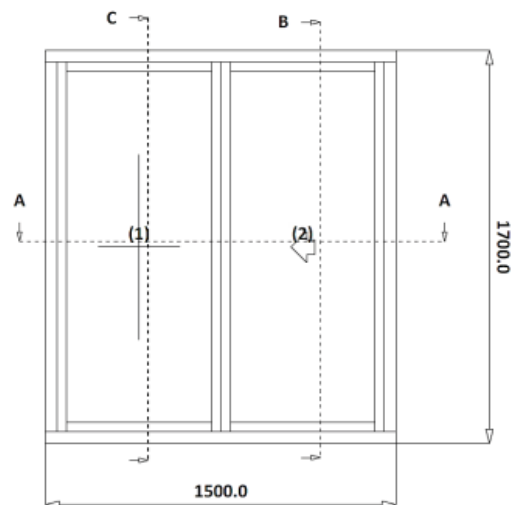

PRUEBA DE PERMEABILIDAD DEL AIRE

RESULTADO	ESCALA	DESCRIPCIÓN
CLASE 2	0 - 4	PÉRDIDA DE AIRE ENTRE ± 50 Y ± 600 Pa. VIENTOS ENTRE ≈ 33 Y ≈ 113 km/h.

PRUEBA DE ESTANQUEIDAD

RESULTADO	DESCRIPCIÓN
0	INGRESO DE AGUA A PARTIR DE 50 Pa.

PRUEBA DE RESISTENCIA A LA CARGA DEL VIENTO

RESULTADO	DESCRIPCIÓN
W1	VALOR NOMINAL DE PRESIÓN 400 Pa. (HASTA 600 Pa.)
B	DEFORMACIÓN CALCULADA ES MAYOR QUE 1/200

Pa.: Pascal equivale a la presión que ejerce la fuerza de 1 Newton sobre una superficie de 1 m².
N.: Newton es la cantidad de fuerza aplicada durante 1 segundo a una masa de 1 kg., para que esta adquiera la velocidad de 1 metro por segundo.

TIPOLOGÍA XX ANTIGAS

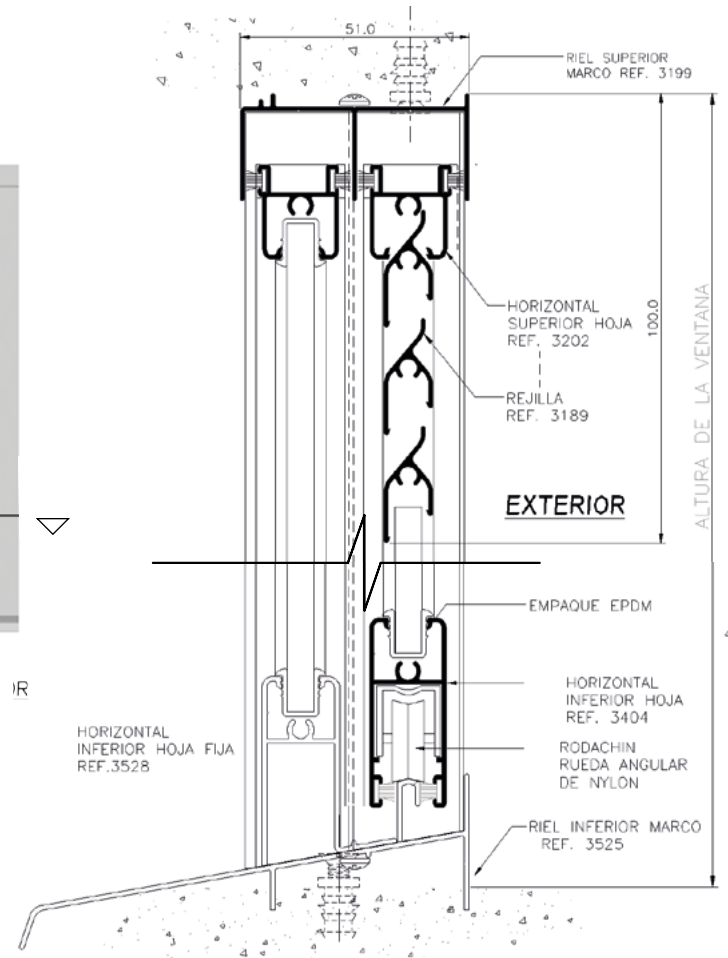
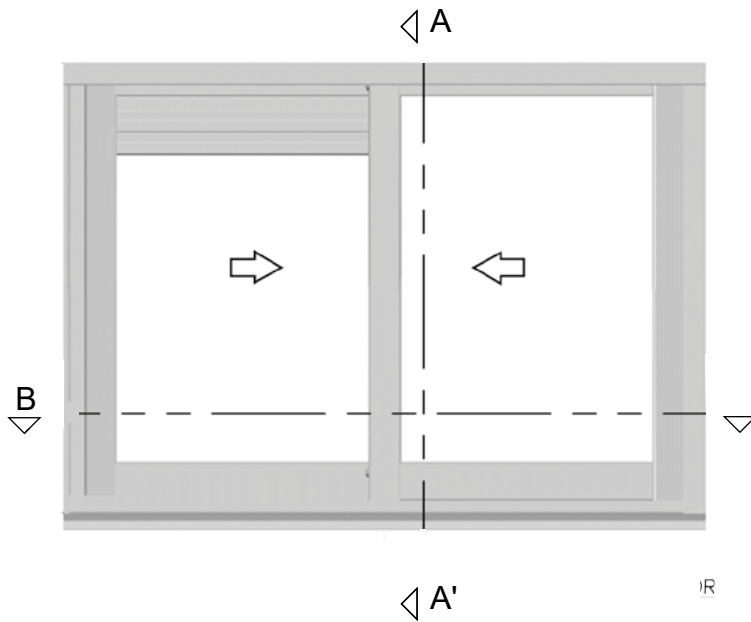

CORTE A-A'

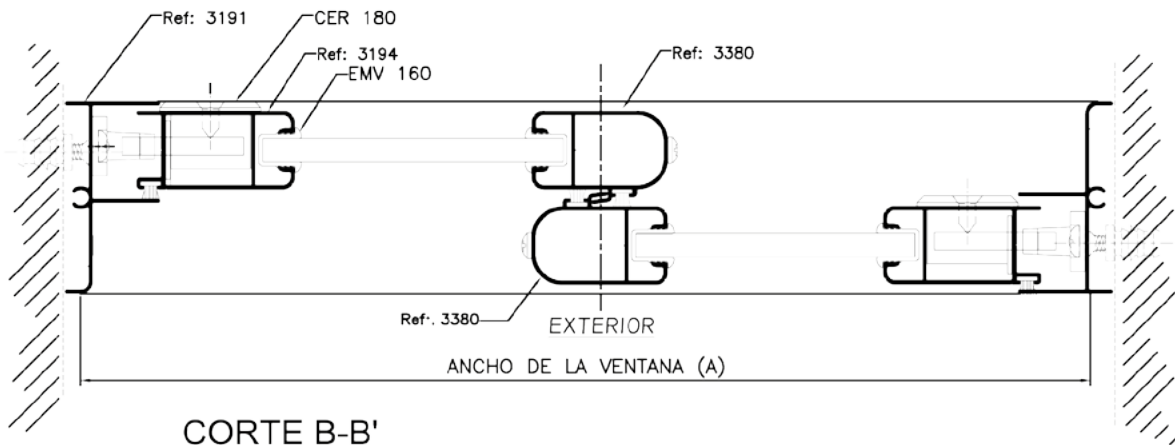

CORTE B-B'

TIPOLOGÍAS

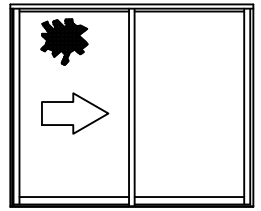

DISEÑO XO

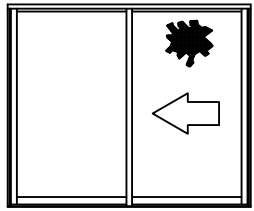

DISEÑO OX

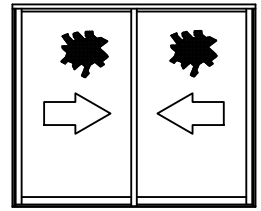

DISEÑO XX

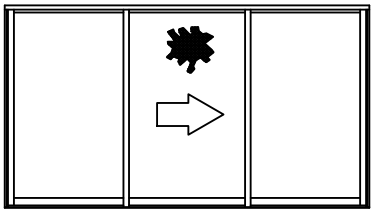

DISEÑO OXO-DER

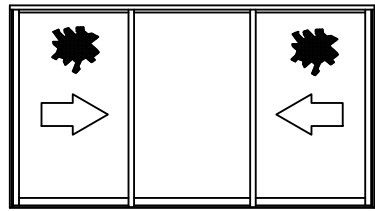

DISEÑO XOx $\frac{1}{3}$

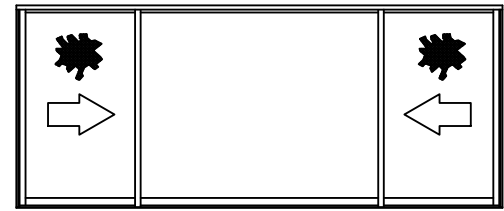

DISEÑO XOx $\frac{1}{4}$

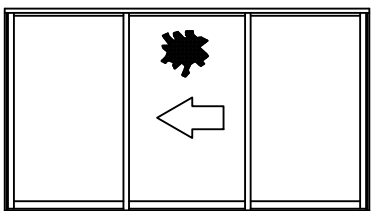

DISEÑO OXO-IZQ

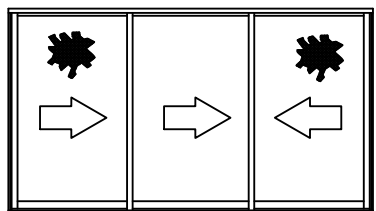

DISEÑO XXX

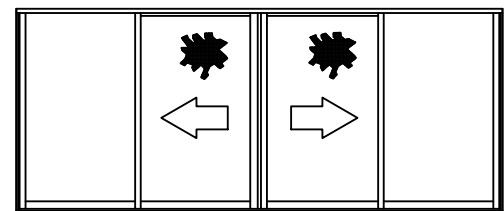

DISEÑO OXO

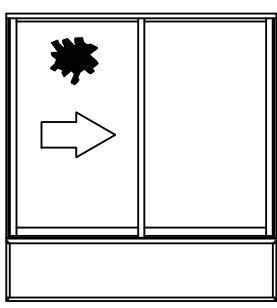

DISEÑO XO/O

TABLA DE ALTURAS REJILLA ANTIGAS	
Nº REJILLAS	ALTURA REJILLA
2	100
4	124
5	+24

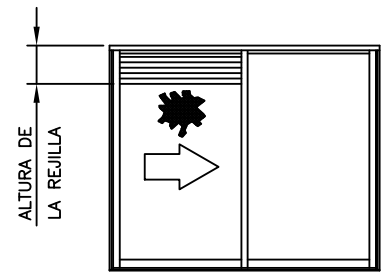

DISEÑO XO ANTIGAS

* Sistema Anjeo opcional.

REFERENCIAS BÁSICAS

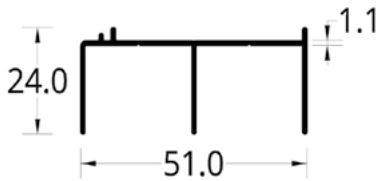

3199	CABEZAL ASTRAL 1.7/2.0 (51 X 24) mm.
PESO	0,332 Kg/m
PERIMETRO	0,332 mm
UE	18

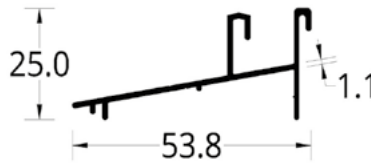

3521	SILLAR UN RIEL ASTRAL 1.7/2.0 (53.8 X 25) mm.
PESO	0,324 Kg/m
PERIMETRO	0,2187 mm
UE	12



3191	JAMBA ASTRAL 1.7/1.8/2.0 (48.6 X 24) mm.
PESO	0,304 Kg/m
PERIMETRO	0,2034 mm
UE	24

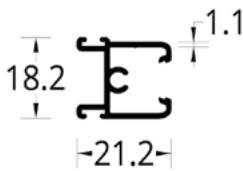

3202	HORIZONTAL SUPERIOR ASTRAL 1.7/2.0 (21.2 X 18.2) mm.
PESO	0,235 Kg/m
PERIMETRO	0,1636 mm
UE	24

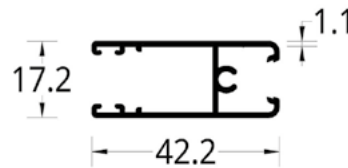

3404	HORIZONTAL INFERIOR ASTRAL 1.7/1.8/2.0 (42.2 X 17.2) mm.
PESO	0,379 Kg/m
PERIMETRO	0,2571 mm
UE	24

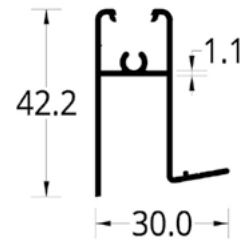

3528	HORIZONTAL INFERIOR FIJO ASTRAL 1.7 (30 X 42.2) mm.
PESO	0,377 Kg/m
PERIMETRO	0,2532 mm
UE	12

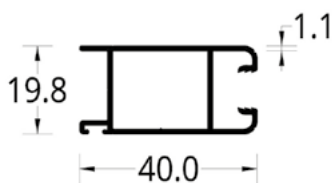

3194	TRASLAPE ASTRAL 1.7/1.8/2.0 (40 X 19.8) mm.
PESO	0,388 Kg/m
PERIMETRO	0,187 mm
UE	24

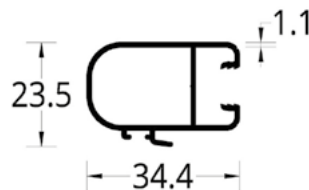

3380	ENGANCHE ASTRAL 1.7/1.8 (34.4 X 23.5) mm.
PESO	0,339 Kg/m
PERIMETRO	0,1706 mm
UE	24

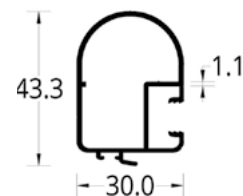

3203	ENGANCHE ASTRAL 1.7/1.8/2.0 (30 X 43.3) mm.
PESO	0,505 Kg/m
PERIMETRO	0,1957 mm
UE	12

REFERENCIAS OPCIONALES

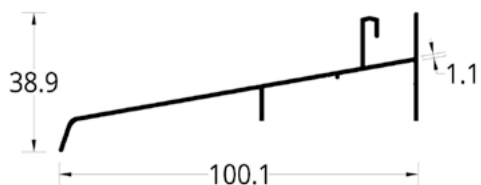

3525	SILLAR ALFAJIA UN RIEL ASTRAL 1.7/2.0 (100.1 X 38.9) mm.
PESO	0,479 Kg/m
PERIMETRO	0,3366 mm
UE	10

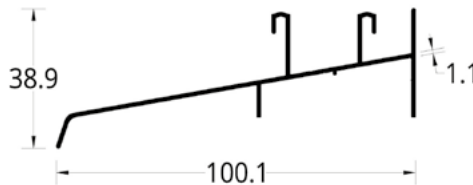

3381	SILLAR ALFAJIA ASTRAL 1.7/2.0 (100.1 X 38.9) mm.
PESO	0,552 Kg/m
PERIMETRO	0,287 mm
UE	12

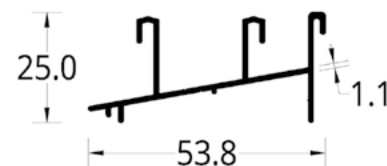

3200	SILLAR ASTRAL 1.7/2.0 (53.8 X 25) mm.
PESO	0,4 Kg/m
PERIMETRO	0,2685 mm
UE	18

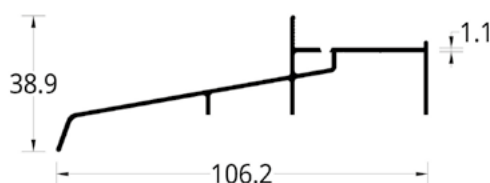

3522	SILLAR ALFAJIA CUERPO FIJO ASTRAL 1.6/1.7 (106.2 X 38.9) mm.
PESO	0,52 Kg/m
PERIMETRO	0,3041 mm
UE	12

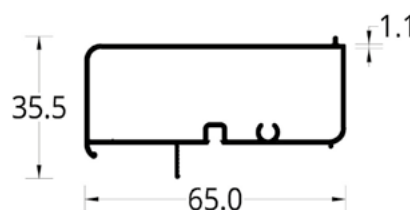

3198	DIVISOR PANORAMICO/MONTANTE ASTRAL 1.7 (65 X 35.5) mm.
PESO	0,607 Kg/m
PERIMETRO	0,2158 mm
UE	12

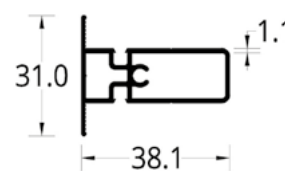

3436	DIVISOR VERTICAL CUERPO FIJO ASTRAL 1.6/1.7 (38.1 X 31) mm.
PESO	0,419 Kg/m
PERIMETRO	0,1563 mm
UE	12

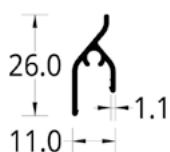

3189	ANTIGAS/ANTICONDENSACION (11 X 26) mm.
PESO	0,143 Kg/m
PERIMETRO	0,0928 mm
UE	48

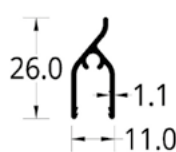

3523	ANTIGAS/ANTICONDENSACION ALETAS IGUALES (11 X 26) mm.
PESO	0,162 Kg/m
PERIMETRO	0,1061 mm
UE	30

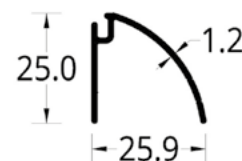

3206	PISADOR ASTRAL 1.7/2.0/COLOSAL 2.6 (25.9 X 25) mm
PESO	0,213 Kg/m
PERIMETRO	0,1327 mm
UE	24

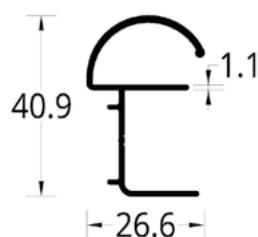

3197	ADAPTADOR ASTRAL 1.7/1.8 (26.6 X 40.9) mm.
PESO	0,348 Kg/m
PERIMETRO	0,348 mm
UE	24

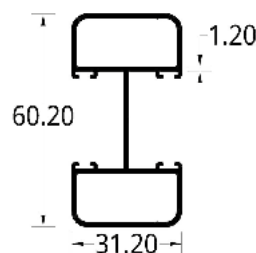

4968	ADAPTADOR REFORZADO 1.7/2.0 (60.2 X 31.2) mm.
PESO	0,740 Kg/m
PERIMETRO	0,278 mm
UE	6

REFERENCIAS SISTEMA ANJEO



3204	CABEZAL ANJEO (30.6 X 24) mm.	
PESO 0,228 Kg/m	PERIMETRO 0,1285 mm	UE 24

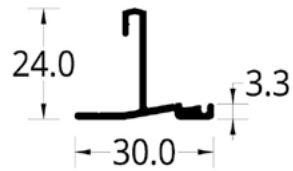

3205	SILLAR ANJEO (30 X 24) mm.	
PESO 0,245 Kg/m	PERIMETRO 0,127 mm	UE 24

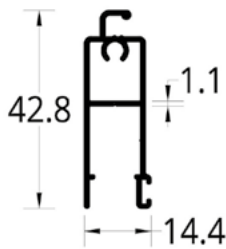

3196	PERIMETRAL ANJEO (14.4 X 42.8) mm.	
PESO 0,362 Kg/m	PERIMETRO 0,1775 mm	UE 24

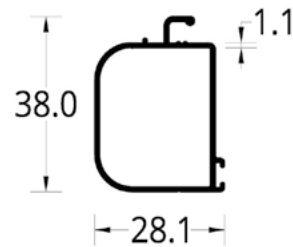

3217	VERTICAL ANJEO (28.1 X 38) mm.	
PESO 0,367 Kg/m	PERIMETRO 0,1435 mm	UE 16

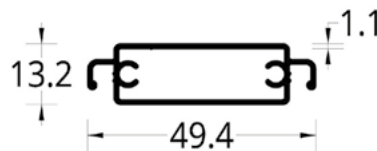

3218	DIVISOR ANJEO (49.4 X 13.2) mm.	
PESO 0,409 Kg/m	PERIMETRO 0,1431 mm	UE 16

PRESIONES, RESISTENCIAS Y TAMAÑOS

Cumpliendo las especificaciones de las Normas Colombianas de Diseño y Construcción Sismo resistente NSR-10, con el decreto 0340 de febrero de 2012, específicamente el Capítulo B.6, como base de análisis realizamos el cálculo para las presiones de viento de las principales ciudades de Colombia como Bogotá (Región 2), Cali (Región 3), Medellín (Región 4) y Barranquilla (Región 5) según la figura B.6.4-1 en la

región eólica específica de cada ciudad, con exposición B, factor de importancia I y sin afectación topográfica; para el caso particular de indicar la metodología de análisis se considerara la ciudad de Bogotá como ejemplo a una altura máxima de instalación del sistema de ventanearía a 50 m sobre el nivel del andén. Este análisis se muestra en el siguiente cuadro:



TABLA DE RESTRICCIONES TR-01

VERTICAL
Vertical perfil 2 3380

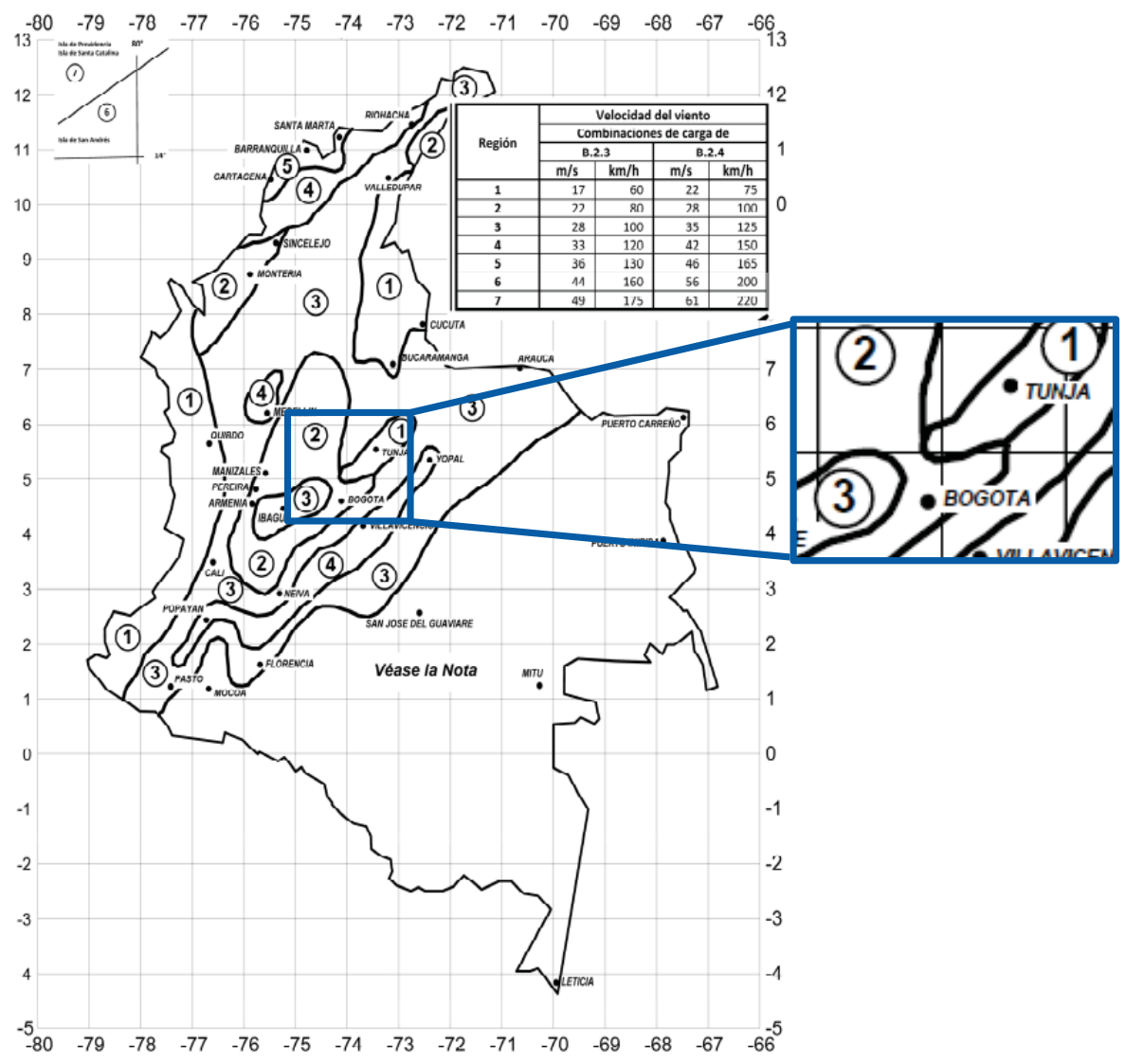
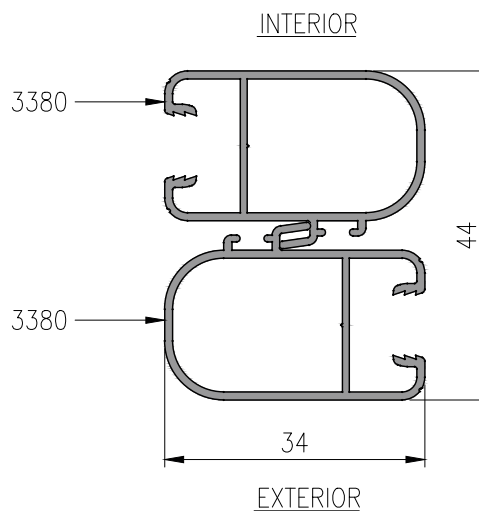
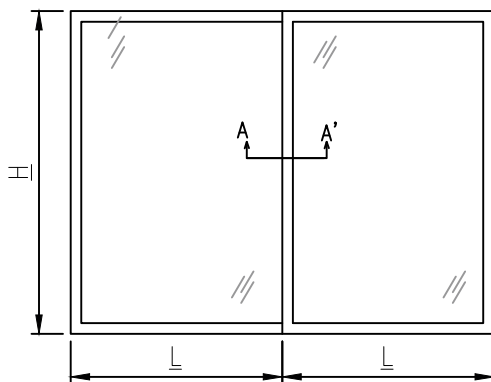

Sección A-A'
Escala 1:1

Altura de la ventana H [m]	1.50	0.43																
	1.40	0.53	0.43															
	1.30	0.67	0.54	0.47	0.41													
	1.20	0.85	0.70	0.60	0.53	0.49	0.46	0.44	0.43	0.42	0.42	0.42	0.42	0.42	0.42	0.42	0.42	0.42
	1.10	1.11	0.92	0.80	0.71	0.66	0.62	0.61	0.60	0.60	0.60	0.60	0.60	0.60	0.60	0.60	0.60	0.60
	1.00	1.50	1.25	1.09	0.99	0.92	0.89	0.88	0.88	0.88	0.88	0.88	0.88	0.88	0.88	0.88	0.88	0.88
	0.90	2.09	1.75	1.55	1.42	1.36	1.34	1.34	1.34	1.34	1.34	1.34	1.34	1.34	1.34	1.34	1.34	1.34
	0.80	3.04	2.58	2.32	2.19	2.14	2.14	2.14	2.14	2.14	2.14	2.14	2.14	2.14	2.14	2.14	2.14	2.14
	0.70	4.68	4.06	3.75	3.65	3.65	3.65	3.65	3.65	3.65	3.65	3.65	3.65	3.65	3.65	3.65	3.65	3.65
	0.60	7.83	7.01	6.76	6.76	6.76	6.76	6.76	6.76	6.76	6.76	6.76	6.76	6.76	6.76	6.76	6.76	6.76
OX, XO, OXO,	0.40	0.50	0.60	0.70	0.80	0.90	1.00	1.10	1.20	1.30	1.40	1.50	1.60	1.70	1.80			
XOX	Ancho de nave L [m]																	
PRESION RESISTENTE [kN/m²]																		

NOTAS:

- Se considera un factor de deflexión máxima horizontal de $L/175$
- Se considera uso de aluminio extruido aleación 6063 T5.
- Se deben evaluar las presiones particulares de cada proyecto y la zona de exposición de la ventana, centrales (zona 4) y esquina (zona 5), ver figura B.6.5-14 (NSR10).
- La presente tabla no aplica para vidrios DVH/ Cámara.

TABLA DE RESTRICCIONES TR-02

VERTICAL
Enganche perfiles 3380 + 3203

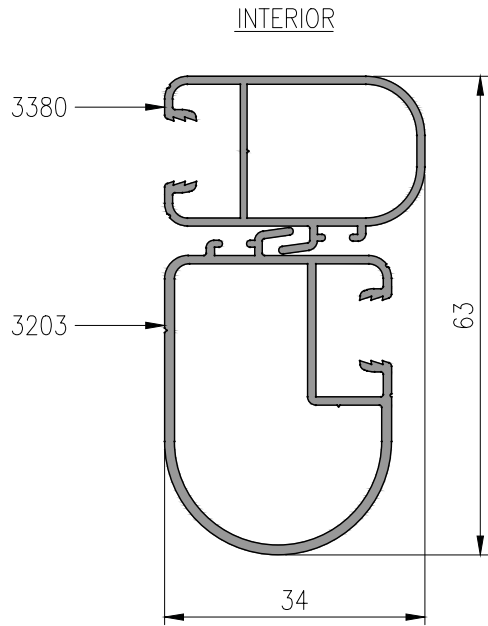
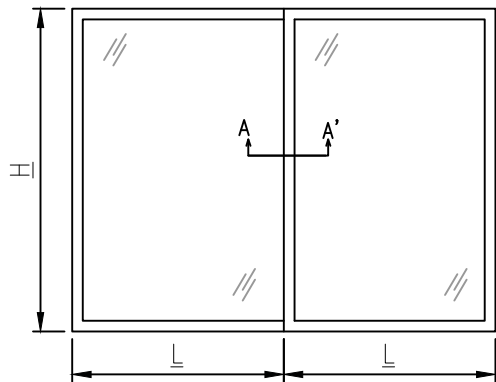

EXTERIOR
Sección A-A'
Escala 1:1

Altura de la ventana H [m]	1.80	0.64	0.52	0.44													
	1.70	0.76	0.62	0.52	0.45	0.41											
	1.60	0.91	0.74	0.63	0.55	0.49	0.45	0.42	0.40								
	1.50	1.11	0.90	0.77	0.68	0.61	0.56	0.52	0.49	0.47	0.46	0.45	0.45	0.45	0.45	0.45	0.45
	1.40	1.37	1.12	0.95	0.84	0.76	0.70	0.66	0.63	0.61	0.60	0.59	0.59	0.59	0.59	0.59	0.59
	1.30	1.73	1.41	1.21	1.07	0.97	0.90	0.85	0.82	0.80	0.80	0.80	0.80	0.80	0.80	0.80	0.80
	1.20	2.21	1.81	1.56	1.39	1.27	1.19	1.14	1.11	1.10	1.10	1.10	1.10	1.10	1.10	1.10	1.10
	1.10	2.89	2.38	2.06	1.85	1.71	1.62	1.57	1.55	1.55	1.55	1.55	1.55	1.55	1.55	1.55	1.55
	1.00	3.88	3.23	2.81	2.56	2.39	2.31	2.27	2.27	2.27	2.27	2.27	2.27	2.27	2.27	2.27	2.27
	0.90	5.42	4.54	4.01	3.69	3.53	3.46	3.46	3.46	3.46	3.46	3.46	3.46	3.46	3.46	3.46	3.46
0.80	7.22	6.08	5.43	5.09	4.96	4.96	4.96	4.96	4.96	4.96	4.96	4.96	4.96	4.96	4.96	4.96	
0.70	9.69	8.34	7.64	7.40	7.40	7.40	7.40	7.40	7.40	7.40	7.40	7.40	7.40	7.40	7.40	7.40	
OX, XO, OXO, XOX	0.40	0.50	0.60	0.70	0.80	0.90	1.00	1.10	1.20	1.30	1.40	1.50	1.60	1.70	1.80	1.80	
Ancho de nave L [m]																	
PRESION RESISTENTE [kN/m²]																	

NOTAS:

- Se considera un factor de deflexion maxima horizontal de L/175
- Se considera uso de aluminio extruido aleacion 6063 T5.
- Se deben evaluar las presiones particuales de cada proyecto y la zona de exposicion de la ventana, centrales (zona 4) y esquina (zona 5), ver figura B.6.5-14 (NSR10).
- La presente tabla no aplica para vidrios DVH/ Camara.

TABLA DE RESTRICCIONES TR-04

VERTICAL

Enganche perfiles 2 3194 + 4968

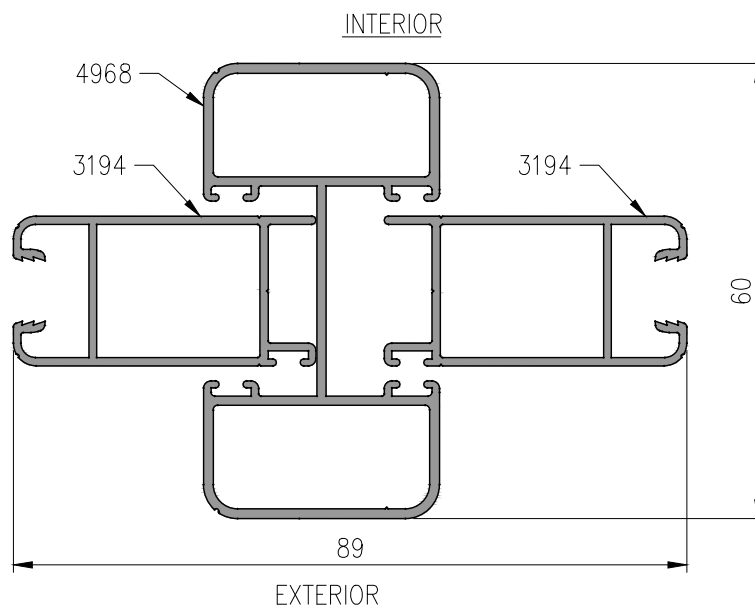
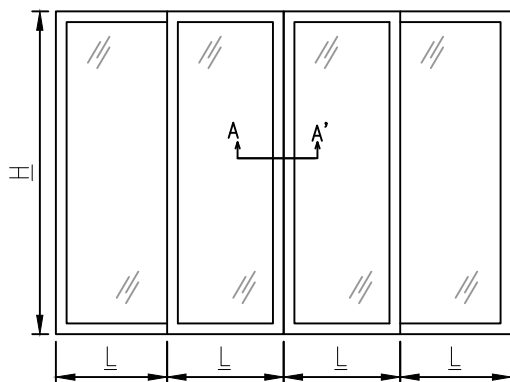

Sección A-A'
Escala 1:1

Altura de la ventana H [m]	1.80	1.39	1.21	1.08	0.98	0.91	0.85	0.80	0.77	0.74	0.72	0.70	0.70	0.69
	1.70	1.66	1.45	1.30	1.18	1.09	1.02	0.97	0.93	0.90	0.89	0.87	0.87	0.87
	1.60	2.00	1.75	1.57	1.44	1.33	1.26	1.20	1.16	1.13	1.11	1.11	1.11	1.11
OXO, OXXO	0.60	0.70	0.80	0.90	1.00	1.10	1.20	1.30	1.40	1.50	1.60	1.70	1.80	1.80
Ancho de nave L [m]														
PRESION RESISTENTE [kN/m²]														

NOTAS:

- Se considera un factor de deflexion maxima horizontal de $L/175$
- Se considera uso de aluminio extruido aleacion 6063 T5.
- Se deben evaluar las presiones particuales de cada proyecto y la zona de exposicion de la ventana, centrales (zona 4) y esquina (zona 5), ver figura B.6.5-14 (NSR10).
- La presente tabla no aplica para vidrios DVH/ Camara.

TABLA DE DESCUENTOS TIPOLOGÍAS OX-XO

Ancho	(A)
Alto	(H)

O	Fijo
X	Móvil

Marco				
Referencia	Descripción	Cantidad	Formula de corte	Cortes
3199	CABEZAL ASTRAL 1.7/2.0 (51 X 24) mm.	1	A= Ancho	90° extremos.
3521	SILLAR UN RIEL ASTRAL 1.7/2.0 (53.8 X 25) mm.	1	A= Ancho	90° extremos.
3525	SILLAR ALFAJIA UN RIEL ASTRAL 1.7/2.0 (100.1 X 38.9) mm.	1	A= Ancho	90° extremos.
3191	JAMBA ASTRAL 1.7/1.8/2.0 (48.6 X 24) mm.	2	H-8	10° extremo inferior 90° superior
Naves fija y movil enganche 3203				
Referencia	Descripción	Cantidad	Formula de corte	Cortes
3202	HORIZONTAL SUPERIOR ASTRAL 1.7/2.0 (21.2 X 18.2) mm.	2	(A/2) -11	90° extremos.
3404	HORIZONTAL INFERIOR ASTRAL 1.7/1.8/2.0 (42.2 X 17.2) mm.	1	(A/2) -11	90° extremos.
3528	HORIZONTAL INFERIOR FIJO ASTRAL 1.7 (30 X 42.2) mm.	1	(A/2) -11	90° extremos.
3194	TRASLAPE ASTRAL 1.7/1.8/2.0 (40 X 19.8) mm.	1	H-22	10° extremo inferior 90° superior.
3194	TRASLAPE ASTRAL 1.7/1.8/2.0 (40 X 19.8) mm.	1	H-35	90° extremos.
3380	ENGANCHE ASTRAL 1.7/1.8 (34.4 X 23.5) mm.	1	H-22	10° extremo inferior 90° superior.
3380	ENGANCHE ASTRAL 1.7/1.8 (34.4 X 23.5) mm.	1	H-35	90° extremos.
3203	ENGANCHE ASTRAL 1.7/1.8/2.0 (30 X 43.3) mm.	1	H-22	10° extremo inferior 90° superior.
3203	ENGANCHE ASTRAL 1.7/1.8/2.0 (30 X 43.3) mm.	1	H-35	90° extremos.

TIPOLOGÍA XX

Marco				
Referencia	Descripción	Cantidad	Formula de corte	Cortes
3199	CABEZAL ASTRAL 1.7/2.0 (51 X 24) mm.	1	A= Ancho	90° extremos.
3200	SILLAR ASTRAL 1.7/2.0 (53.8 X 25) mm.	1	A= Ancho	90° extremos.
3191	JAMBA ASTRAL 1.7/1.8/2.0 (48.6 X 24) mm.	2	H-8	10° extremo inferior 90° superior.
Naves fija y movil enganche 3203				
Referencia	Descripción	Cantidad	Formula de corte	Cortes
3202	HORIZONTAL SUPERIOR ASTRAL 1.7/2.0 (21.2 X 18.2) mm.	2	(A/2) -11	90° extremos.
3193	HORIZONTAL INFERIOR ASTRAL 1.8/2.0 (57 X 17.2) mm.	2	(A/2) -11	90° extremos.
3194	TRASLAPE ASTRAL 1.7/1.8/2.0 (40 X 19.8) mm.	2	H-35	90° extremos.
3380	ENGANCHE ASTRAL 1.7/1.8 (34.4 X 23.5) mm.	2	H-35	90° extremos.
3203	ENGANCHE ASTRAL 1.7/1.8/2.0 (30 X 43.3) mm.	1	H-35	90° extremos.

TIPOLOGÍAS OXXO

Ancho	(A)	O	Fijo
Alto	(H)	X	Móvil

Marco				
Referencia	Descripción	Cantidad	Formula de corte	Cortes
3199	CABEZAL ASTRAL 1.7/2.0 (51 X 24) mm.	1		90° extremos.
3521	SILLAR UN RIEL ASTRAL 1.7/2.0 (53.8 X 25) mm.	1	A= Ancho	90° extremos.
3525	SILLAR ALFAJIA UN RIEL ASTRAL 1.7/2.0 (100.1 X 38.9) mm.	1	A= Ancho	90° extremos.
3191	JAMBA ASTRAL 1.7/1.8/2.0 (48.6 X 24) mm.	2	H-8	10° extremo inferior 90° superior.

TIPOLOGÍAS XOX (X1/4)

Naves fija y movil enganche 3203				
Referencia	Descripción	Cantidad	Formula de corte	Cortes
3202	HORIZONTAL SUPERIOR ASTRAL 1.7/2.0 (21.2 X 18.2) mm.	2	(A/4) + 2	90° extremos.
3202	HORIZONTAL SUPERIOR ASTRAL 1.7/2.0 (21.2 X 18.2) mm.	1	(A/4) +124	90° extremos nave fija.
3193	HORIZONTAL INFERIOR ASTRAL 1.8/2.0 (57 X 17.2) mm.	2	(A/4) + 2	90° extremos.
3528	HORIZONTAL INFERIOR FIJO ASTRAL 1.7 (30 X 42.2) mm.	1	(A/4) +124	90° extremos.
3194	TRASLAPE ASTRAL 1.7/1.8/2.0 (40 X 19.8) mm.	2	H-35	90° extremos.
3380	ENGANCHE ASTRAL 1.7/1.8 (34.4 X 23.5) mm.	2	H-22	10° extremo inferior 90° superior.
3380	ENGANCHE ASTRAL 1.7/1.8 (34.4 X 23.5) mm.	2	H-35	90° extremos.
3203	ENGANCHE ASTRAL 1.7/1.8/2.0 (30 X 43.3) mm.	1	H-22	10° extremo inferior 90° superior.
3203	ENGANCHE ASTRAL 1.7/1.8/2.0 (30 X 43.3) mm.	1	H-35	90° extremos.

ACCESORIOS



KIT DE CIERRE ASTRAL 1.7/2.0	
CER 180F-0 GRIS	UE 50
CER 180F-2 BLANCO	
CER 180F-3 NEGRO	



RODAMIENTO 80 KILOS EN AGUJAS ASTRAL 1.7/1.8	
RDA 170-A	AGUJAS
CARGA Rueda 40Kg. par 80Kg. UE 150	



RODAMIENTO 30 KILOS EN BOLAS ASTRAL 1.7/1.8	
RDA 170-B	BOLAS
CARGA Rueda 15Kg. par 30Kg. UE 150	

ACCESORIOS NAVE DE ANJEO



CAJA DEFLECTORA LINEA UNIVERSAL/EUROVITRAL	
CAD 320	UE 100



CUBETA DE ANJEO NEGRA LINEA UNIVERSAL LINEA EUROVITRAL	
CUB 260F-3	UE 10



RODAMIENTO 22 KILOS EN BOLAS ASTRAL 1.6/MOSQUITERO LINEA UNIVERSAL	
RDA 160	UE 100



GUIA SUPERIOR ANJEO LINEA UNIVERSAL	
GIA 320	UE 100

EMPAQUES



EMPAQUE U PARA VIDRIO 4 MM LINEA ASTRAL	
EMV 160.4	



EMPAQUE U PARA VIDRIO 5 MM LINEA ASTRAL	
EMV 160.5	

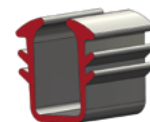

EMPAQUE U PARA VIDRIO 6 MM LINEA ASTRAL	
EMV 160.6	



EMPAQUE U MOVIL PARA VIDRIO 3+3 MM LINEA ASTRAL
EMV 160.3+3

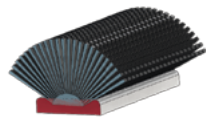

FELPA BASE 5.00 X ALTURA 5.00 MM
FEL 005

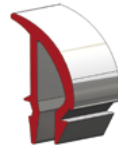

EMPAQUE RIGIDO PARA CUERPO FIJO VIDRIO 4/5/6 MM LINEA ASTRAL
EMV 160.30

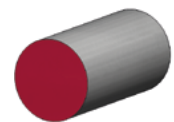

EMPAQUE MOSQUITERO SISTEMA LINEA UNIVERSAL
EMA 160.1

APLICACIÓN DE EMPAQUES

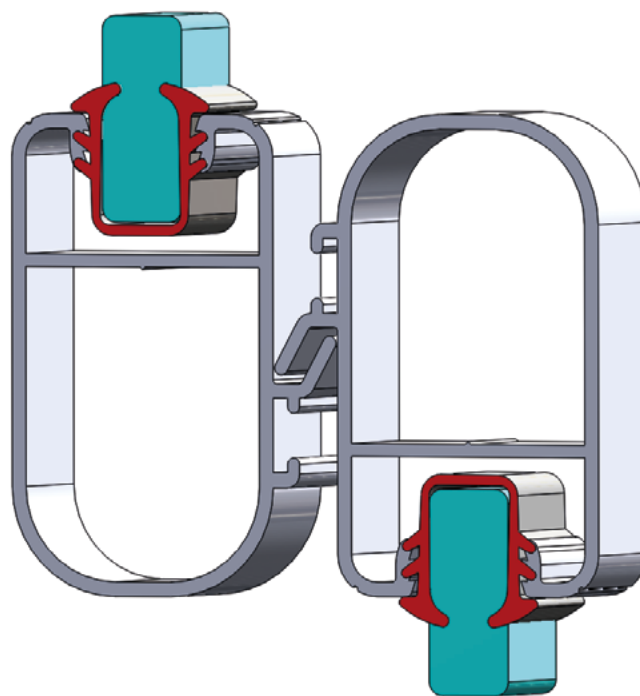



vitral.com.co/folletos



Vitracol



Vitral Bogotá

Cra 52 No. 79-20

Tel: (57) 601 311 6400



Cel: (57) 317 401 8367



Vitral Cali

Cll 25 No. 5-44

Tel: (57) 602 882 2694



Cel: (57) 317 432 6909