



S I S T E M A
KIMBAYA

PUERTA CORREDIZA



vitral.com.co/catalogos



PUERTA CORREDIZA

3 | DESCRIPCIÓN

RESULTADO: TEST AEV 20-007 | 4

5 | TIPOLOGIA OX CON ANJEO

TIPOLOGÍAS | 6

7 | REFERENCIAS BÁSICAS

TABLAS DE DESCUENTOS | 9

11 | ACCESORIOS DE MARCO

ACCESORIOS HOJA FIJA | 12

13 | ACCESORIOS HOJA MÓVIL

ACCESORIOS | 14

15 | EMPAQUES

MAQUINARIA Y EQUIPO | 16



PUERTA CORREDIZA

- Perfiles de tamaño uniforme donde se aprecia la esbeltez y armonía de líneas.
- Perfiles tubulares que proporcionan resistencia, solidez y estabilidad, con cavidad de cámara europea para el alojamiento de accesorios.
- Tipologías posibles: XOX 1/3, XO, OX, XOX 1/4, XXX 1/3, XX.
- Marco y naves que se arman a 45 grados con escuadras de aluminio fundido, de bulón y arrastre.
- Posibilidad de usar cristales con espesores desde 6, 8, 10 mm con las referencias 3707 y 3708.
- Posibilidad de usar vidrio cámara hasta 22mm con las referencias 3709 y 3710.
- Rodamientos en agujas, con ruedas simples o dobles, con pista radial con la referencia 3712, que permite cargas hasta de 200 kg. por nave.
- Cierres de multipunto, en acero inoxidable y poliamida, se fijan sin mecanización.
- Cremona o manija para cierres multipunto.
- Conjunto de accesorios para las naves móvil y fija de fácil manejo, identificación y montaje.
- Uso de felpa de base 5mm x altura 7mm, con o sin film central, al igual que empaque burbuja EMB 001 perimetral en las naves para mayor sello.

RESULTADO: TEST AEV 20-007

AGOSTO 24: 2020 – FAPIM, ITALIA

MEDIDAS: (axh) 2.000 x 2.400 mm

AREA: 4.8 m²

TIPOLOGÍA: ASTAL V.C. 2.0 - PC - OX

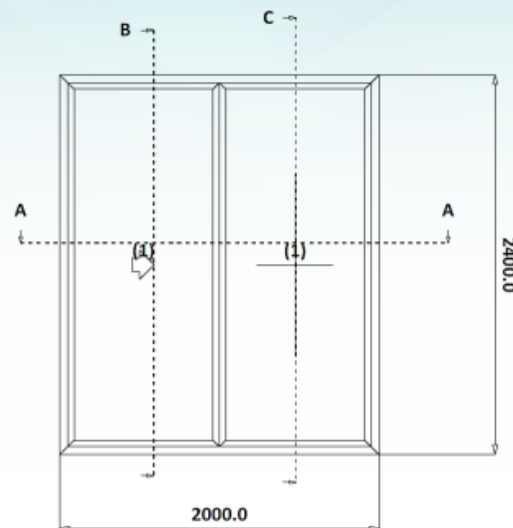

DESCRIPCIÓN DE LAS PRUEBAS	CLASE	ESTANDAR EUROPEO
PERMEABILIDAD AL AIRE	2	UNI EN 1026 - UNI EN 12207
ESTANQUEIDAD	A1	UNI EN 1027 - UNI EN 12208
RESISTENCIA A LA CARGA DEL VIENTO	W2A	UNI EN 12211 - UNI EN 12210

PRUEBA DE PERMEABILIDAD DEL AIRE

RESULTADO	ESCALA	DESCRIPCIÓN
CLASE 2	0 - 4	PÉRDIDA DE AIRE ENTRE ± 50 Y ± 600 Pa. VIENTOS ENTRE ≈ 33 Y ≈ 113 km/h.

PRUEBA DE ESTANQUEIDAD

RESULTADO	DESCRIPCIÓN
A1	INGRESO DE AGUA A PARTIR DE 50 Pa.

PRUEBA DE RESISTENCIA A LA CARGA DEL VIENTO

RESULTADO	DESCRIPCIÓN
W2	VALOR NOMINAL DE PRESIÓN 800 Pa. (HASTA 1.2000 Pa.)
A	DEFORMACIÓN CALCULADA ES MAYOR QUE 1/150

Pa.: Pascal equivale a la presión que ejerce la fuerza de 1 Newton sobre una superficie de 1 m².
N.: Newton es la cantidad de fuerza aplicada durante 1 segundo a una masa de 1 kg., para que esta adquiera la velocidad de 1 metro por segundo.

TIPOLOGIA OX CON ANJEO

INDICE

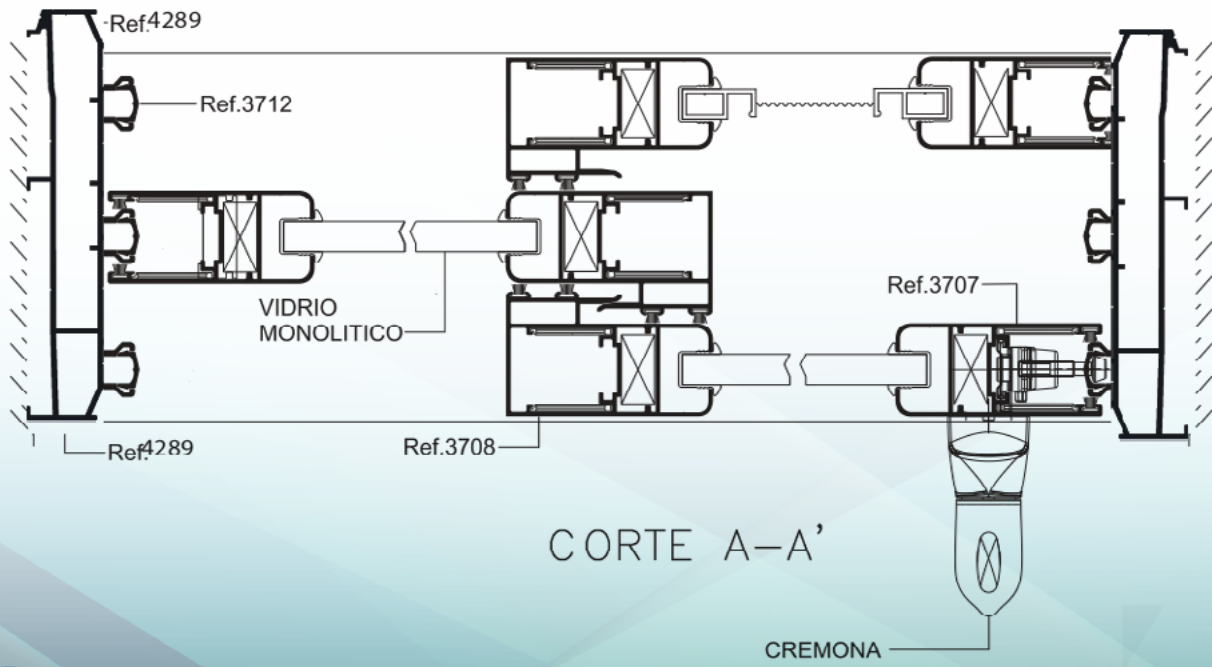
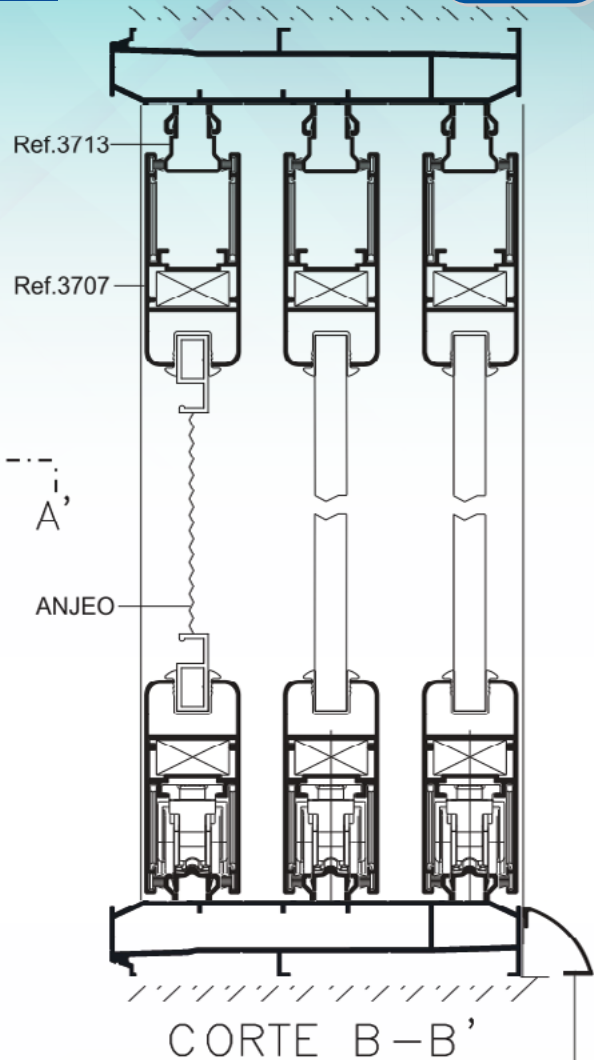
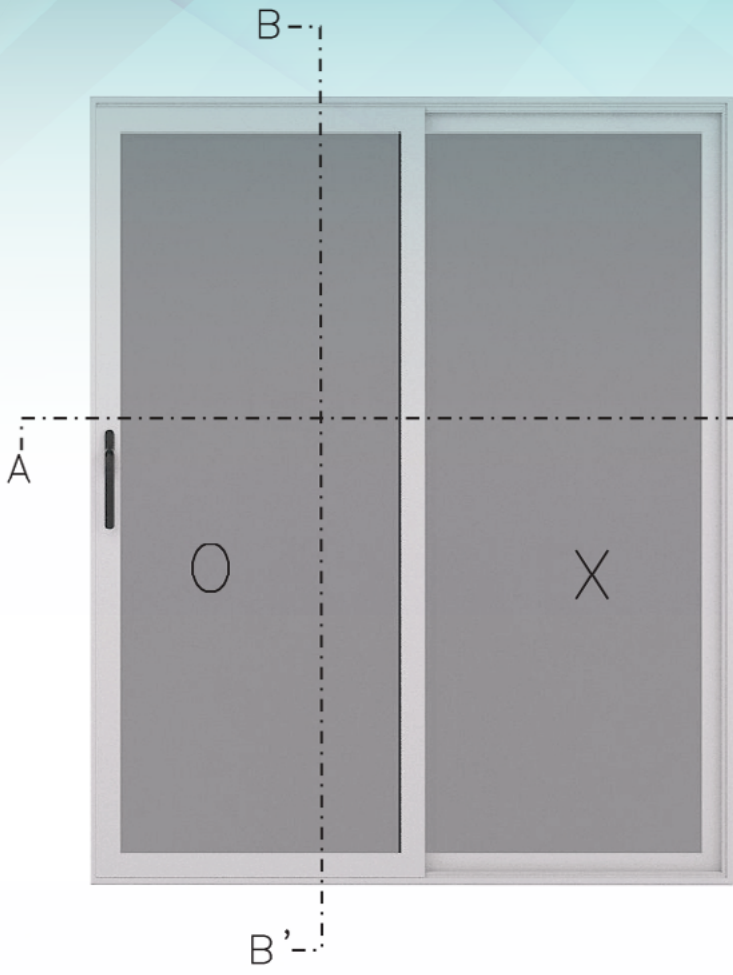

TIPOLOGÍAS

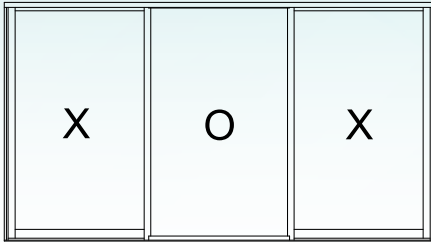

DISEÑO XOX $\frac{1}{3}$

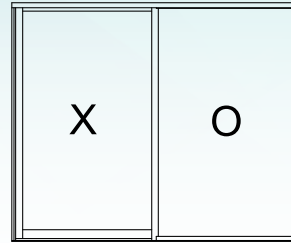

DISEÑO XO

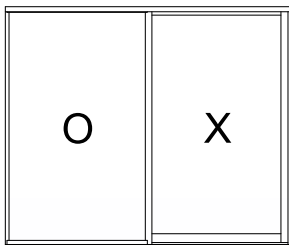

DISEÑO OX

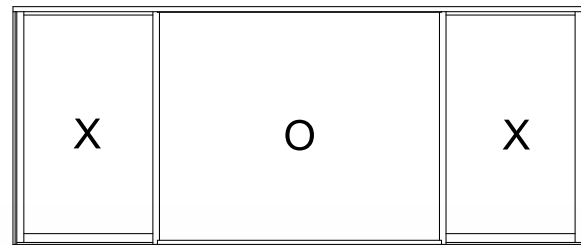

DISEÑO XOX $\frac{1}{4}$

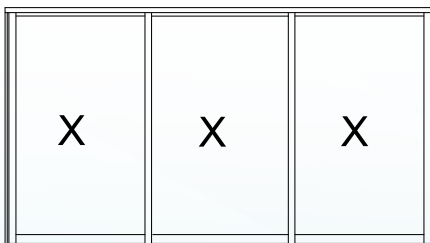

DISEÑO XXX $\frac{1}{3}$

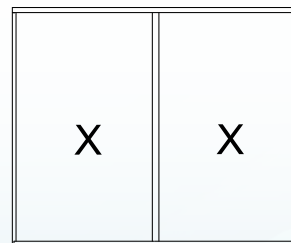

DISEÑO XX

REFERENCIAS BÁSICAS

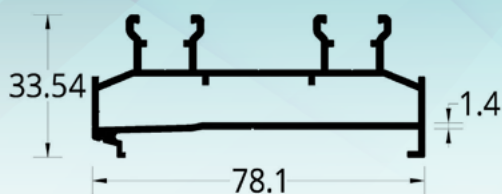

4288	MARCO PERIMETRAL KIMBAYA/ KALIMA (78.1 X 33.54) mm.	
PESO	PERIMETRO	UE
1.046 Kg/m	0,346 mm	4

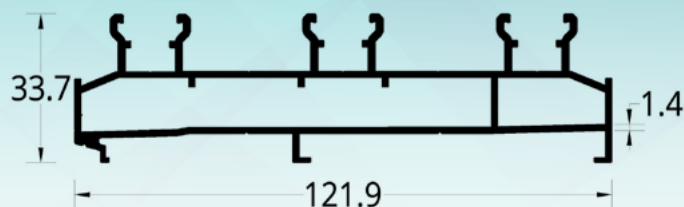

4289	MARCO PERIMETRAL KIMBAYA/KALIMA TRES RIELES (121.9 X 33.54)	
PESO	PERIMETRO	UE
1.589 Kg/m	0,529 mm	2

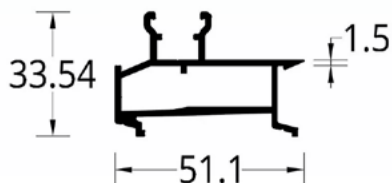

3706	COMPLEMENTO DE MARCO KIMBAYA/KALIMA (121.8 X 33.54) mm.	
PESO	PERIMETRO	UE
0,734 Kg/m	0,2293 mm	6

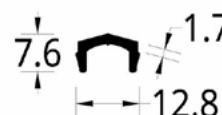

3712	PISTA RODAMIENTO KIMBAYA VERTICAL KIMBAYA/KALIMA (12.8 X 7.6) mm.	
PESO	PERIMETRO	UE
0,099 Kg/m	0,0449 mm	48

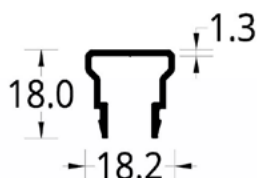

3713	COMPLEMENTO SUPERIOR MARCO KIMBAYA/KALIMA (18.2 X 18) mm.	
PESO	PERIMETRO	UE
0,205 Kg/m	0,1117 mm	24

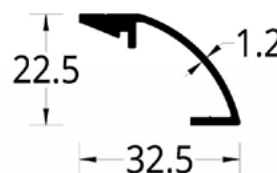

3714	TROPEZON INT./EXT. KIMBAYA/KALIMA (32.5 X 22.5) mm.	
PESO	PERIMETRO	UE
0,254 Kg/m	0,254 mm	24

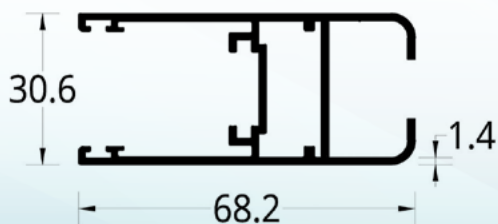

3707	VERTICAL HORIZONTALES VIDRIO 6/8/10 mm. KIMBAYA/KALIMA (68.2 X 30.6) mm.	
PESO	PERIMETRO	UE
0,958 Kg/m	0,3842 mm	6

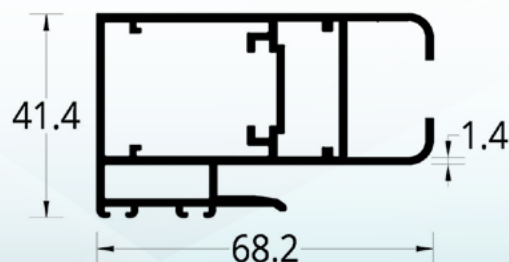

3708	ENGANCHE VIDRIO 6/8/10 mm. KIMBAYA/KALIMA (68.2 X 41.4) mm.	
PESO	PERIMETRO	UE
1.332 Kg/m	0,3361 mm	4

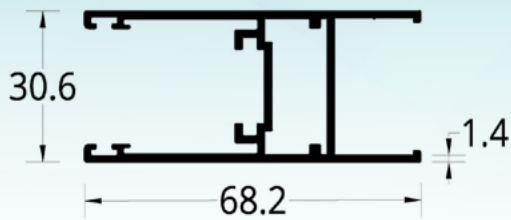

3709	VERTICAL HORIZONTALES VIDRIO CAMARA HASTA 22 mm. KIMBAYA/KALIMA (68.2 X 30.6) mm
PESO 0,915 Kg/m	PERIMETRO 0,3618 mm
	UE 6

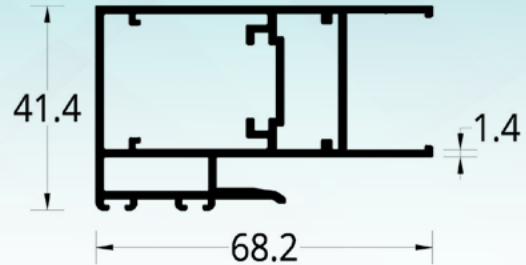

3710	ENGANCHE VIDRIO CAMARA HASTA 22 mm. KIMBAYA/KALIMA (68.2 X 41.4) mm.
PESO 1,288 Kg/m	PERIMETRO 0,3067 mm
	UE 4

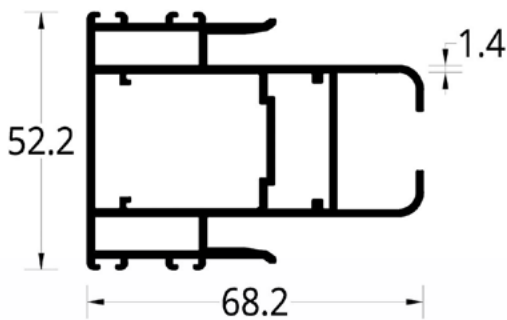

3809	DOBLE ENGANCHE VIDRIO 6/8/10 mm. KIMBAYA/KALIMA (68.2 X 52.2) mm.
PESO 1,505 Kg/m	PERIMETRO 0,389 mm
	UE 4

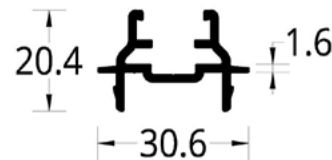

3810	ADAPTADOR KIMBAYA/KALIMA (30.6 X 20.4) mm.
PESO 0,349 Kg/m	PERIMETRO 0,163 mm
	UE 14



3712	TAPA REFUERZO KIMBAYA VERTICAL KIMBAYA/KALIMA (12.8 X 7.6) mm.
PESO 0,099 Kg/m	PERIMETRO 0,0449 mm
	UE 48

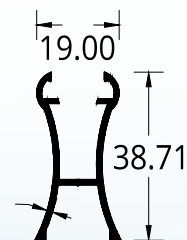

5016	REFUERZO UNIVERSAL COLOSAL 345 - 2.6 KIMBAYA -KALIMA (19.9 X 38.7)
PESO 0,345 Kg/m	PERIMETRO 0,199 mm
	UE 14

TABLAS DE DESCUENTOS TIPOLOGÍA OX- XO

Ancho	(A)	O	Fijo
Alto	(H)	X	Móvil

Referencia	Descripción	Cantidad		Cortes
4288	MARCO PERIMETRAL KIMBAYA/KALIMA (78.1 X 33.54) mm.	2	A= Ancho	45° en los dos extremos
	MARCO PERIMETRAL KIMBAYA/KALIMA (78.1 X 33.54) mm.	2	H= Alto	45° en los dos extremos
3711	PISTA RODAMIENTO KALIMA (12.8 X 8.5) mm.	2	Sillar	90° en los dos extremos
3712	PISTA RODAMIENTO KIMBAYA - VERTICAL KIMBAYA/KALIMA (12.8 X 7.6) mm.	2	Sillar	90° en los dos extremos
	PISTA RODAMIENTO KIMBAYA - VERTICAL KIMBAYA/KALIMA (12.8 X 7.6) mm.	4	Jamba	90° en los dos extremos
3713	COMPLEMENTO SUPERIOR MARCO KIMBAYA/KALIMA (18.2 X 18) mm.	2	Cabezal	90° en los dos extremos
Naves				
Referencia	Descripción	Cantidad	Formula de corte	Cortes
3707	VERTICAL HORIZONTALES VIDRIO 6/8/10 mm. KIMBAYA/KALIMA (68.2 X 30.6) mm.	2 Verticales	H - 60	45° en los dos extremos
	VERTICAL HORIZONTALES VIDRIO 6/8/10 mm. KIMBAYA/KALIMA (68.2 X 30.6) mm.	4 Horizontales	A / 2 + 7	45° en los dos extremos
3708	ENGANCHE VIDRIO 6/8/10 mm. KIMBAYA/KALIMA (68.2 X 41.4) mm.	2	H - 60	45° en los dos extremos
3709	VERTICAL HORIZONTALES VIDRIO CAMARA HASTA 22 mm. KIMBAYA/KALIMA (68.2 X 30.6) mm.	2 Verticales	H - 60	45° en los dos extremos
	VERTICAL HORIZONTALES VIDRIO CAMARA HASTA 22 mm. KIMBAYA/KALIMA (68.2 X 30.6) mm.	4 Horizontales	A / 2 + 7	45° en los dos extremos
3710	ENGANCHE VIDRIO CAMARA HASTA 22 mm. KIMBAYA/KALIMA (68.2 X 41.4) mm.	2	H - 60	45° en los dos extremos

TIPOLOGÍA OXXO

Referencia	Descripción	Cantidad		Cortes
4288	MARCO PERIMETRAL KIMBAYA/KALIMA (78.1 X 33.54) mm.	2	A= Ancho	45° en los dos extremos
	MARCO PERIMETRAL KIMBAYA/KALIMA (78.1 X 33.54) mm.	2	H= Alto	45° en los dos extremos
3711	PISTA RODAMIENTO KALIMA (12.8 X 8.5) mm.	2	Sillar	90° en los dos extremos
3712	PISTA RODAMIENTO KIMBAYA - VERTICAL KIMBAYA/KALIMA (12.8 X 7.6) mm.	2	Sillar	90° en los dos extremos
	PISTA RODAMIENTO KIMBAYA - VERTICAL KIMBAYA/KALIMA (12.8 X 7.6) mm.	4	Jamba	90° en los dos extremos
3713	COMPLEMENTO SUPERIOR MARCO KIMBAYA/KALIMA (18.2 X 18) mm.	2	Cabezal	90° en los dos extremos
Naves				
Referencia	Descripción	Cantidad	Formula de corte	Cortes
3707	VERTICAL HORIZONTALES VIDRIO 6/8/10 mm. KIMBAYA/KALIMA (68.2 X 30.6) mm.	4 Verticales	H - 60	45° en los dos extremos
	VERTICAL HORIZONTALES VIDRIO 6/8/10 mm. KIMBAYA/KALIMA (68.2 X 30.6) mm.	8 Horizontales	A / 4 + 20	45° en los dos extremos
3708	ENGANCHE VIDRIO 6/8/10 mm. KIMBAYA/KALIMA (68.2 X 41.4) mm.	4	H - 60	45° en los dos extremos
3709	VERTICAL HORIZONTALES VIDRIO CAMARA HASTA 22 mm. KIMBAYA/KALIMA (68.2 X 30.6) mm.	4 Verticales	H - 60	45° en los dos extremos
	VERTICAL HORIZONTALES VIDRIO CAMARA HASTA 22 mm. KIMBAYA/KALIMA (68.2 X 30.6) mm.	8 Horizontales	A / 2 + 7	45° en los dos extremos
3710	ENGANCHE VIDRIO CAMARA HASTA 22 mm. KIMBAYA/KALIMA (68.2 X 41.4) mm.	4	A / 4 + 20	45° en los dos extremos
3810	ADAPTADOR KIMBAYA/KALIMA (30.6 X 20.4) mm.	1	H - 60	90° en los dos extremos

TIPOLOGÍA OXX-XXO - XXX

Ancho	(A)	O	Fijo
Alto	(H)	X	Móvil

Referencia	Descripción	Cantidad		Cortes
4289	MARCO PERIMETRAL KIMBAYA/KALIMA TRES RIELES (121.9 X 33.54) mm.	2	A= Ancho	45° en los dos extremos
4289	MARCO PERIMETRAL KIMBAYA/KALIMA TRES RIELES (121.9 X 33.54) mm.	2	H= Alto	45° en los dos extremos
3711	PISTA RODAMIENTO KALIMA (12.8 X 8.5) mm.	3	Sillar	90° en los dos extremos
3712	PISTA RODAMIENTO KIMBAYA - VERTICAL KIMBAYA/KALIMA (12.8 X 7.6) mm.	3	Sillar	90° en los dos extremos
3712	PISTA RODAMIENTO KIMBAYA - VERTICAL KIMBAYA/KALIMA (12.8 X 7.6) mm.	6	Jamba	90° en los dos extremos
3713	COMPLEMENTO SUPERIOR MARCO KIMBAYA/KALIMA (18.2 X 18) mm.	3	Cabezal	90° en los dos extremos
Naves				
Referencia	Descripción	Cantidad	Formula de corte	Cortes
3707	VERTICAL HORIZONTALES VIDRIO 6/8/10 mm. KIMBAYA/KALIMA (68.2 X 30.6) mm.	2 Verticales	H - 60	45° en los dos extremos
	VERTICAL HORIZONTALES VIDRIO 6/8/10 mm. KIMBAYA/KALIMA (68.2 X 30.6) mm.	6 Horizontales	A / 3 + 27	45° en los dos extremos
3708	ENGANCHE VIDRIO 6/8/10 mm. KIMBAYA/KALIMA (68.2 X 41.4) mm.	4	H - 60	45° en los dos extremos
3709	VERTICAL HORIZONTALES VIDRIO CAMARA HASTA 22 mm. KIMBAYA/KALIMA (68.2 X 30.6) mm.	2 Verticales	H - 60	45° en los dos extremos
	VERTICAL HORIZONTALES VIDRIO CAMARA HASTA 22 mm. KIMBAYA/KALIMA (68.2 X 30.6) mm.	6 Horizontales	A / + 27	45° en los dos extremos
3710	ENGANCHE VIDRIO CAMARA HASTA 22 mm. KIMBAYA/KALIMA (68.2 X 41.4) mm.	4	H - 60	45° en los dos extremos

TIPOLOGÍA OXXXXO

Referencia	Descripción	Cantidad		Cortes
4289	MARCO PERIMETRAL KIMBAYA/KALIMA TRES RIELES (121.9 X 33.54) mm.	2	A= Ancho	45° en los dos extremos
4289	MARCO PERIMETRAL KIMBAYA/KALIMA TRES RIELES (121.9 X 33.54) mm.	2	H= Alto	45° en los dos extremos
3711	PISTA RODAMIENTO KALIMA (12.8 X 8.5) mm.	3	Sillar	90° en los dos extremos
3712	PISTA RODAMIENTO KIMBAYA - VERTICAL KIMBAYA/KALIMA (12.8 X 7.6) mm.	3	Sillar	90° en los dos extremos
3712	PISTA RODAMIENTO KIMBAYA - VERTICAL KIMBAYA/KALIMA (12.8 X 7.6) mm.	6	Jamba	90° en los dos extremos
3713	COMPLEMENTO SUPERIOR MARCO KIMBAYA/KALIMA (18.2 X 18) mm.	3	Cabezal	90° en los dos extremos
Naves				
Referencia	Descripción	Cantidad	Formula de corte	Cortes
3707	VERTICAL HORIZONTALES VIDRIO 6/8/10 mm. KIMBAYA/KALIMA (68.2 X 30.6) mm.	4 Verticales	H - 60	45° en los dos extremos
	VERTICAL HORIZONTALES VIDRIO 6/8/10 mm. KIMBAYA/KALIMA (68.2 X 30.6) mm.	12 Horizontales	A / 6 + 36	45° en los dos extremos
3708	ENGANCHE VIDRIO 6/8/10 mm. KIMBAYA/KALIMA (68.2 X 41.4) mm.	8	H - 60	45° en los dos extremos
3709	VERTICAL HORIZONTALES VIDRIO CAMARA HASTA 22 mm. KIMBAYA/KALIMA (68.2 X 30.6) mm.	4 Verticales	H - 60	45° en los dos extremos
	VERTICAL HORIZONTALES VIDRIO CAMARA HASTA 22 mm. KIMBAYA/KALIMA (68.2 X 30.6) mm.	12 Horizontales	A / 6 + 36	H - 60
3710	ENGANCHE VIDRIO CAMARA HASTA 22 mm. KIMBAYA/KALIMA (68.2 X 41.4) mm.	8	H - 60	45° en los dos extremos
3810	ADAPTADOR KIMBAYA/KALIMA (30.6 X 20.4) mm.	1	H - 60	90° en los dos extremos

ACCESORIOS DE MARCO

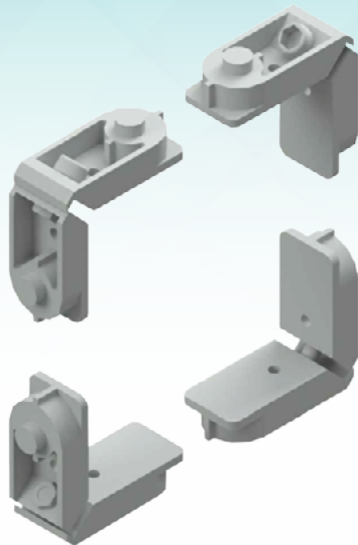

ESCUADRA ENSAMBLE MARCO/HOJA KALIMA/KIMBAYA/ MARCO INFERIOR AWA	
ESQ 01E	UE 1



ESPUMA SELLO SUPERIOR KALIMA/KIMBAYA	
ESP 01M	UE 1

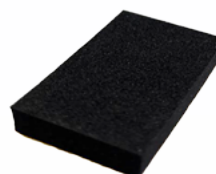

ESPUMA SELLO INFERIOR KALIMA/KIMBAYA	
ESP 02M	UE 1



SIFÓN SISTEMAS EUROVITRAL	
SIF 001	UE 100



CAJA DEFLECTORA LINEA UNIVERSAL/EUROVITRAL	
CAD 320	UE 100

ACCESORIOS HOJA FIJA

INDICE

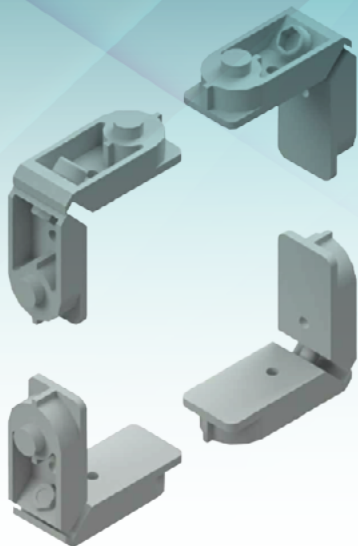

ESCUADRA ENSAMBLE MARCO/HOJA KALIMA/KIMBAYA/ MARCO INFERIOR AWA	
ESQ 01E	UE 1

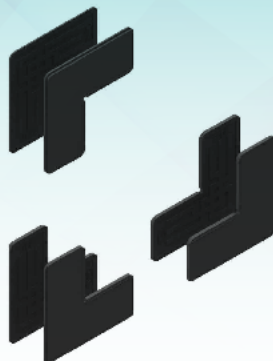

KIT DE 6 ESCUADRAS DE ALINEACIÓN HOJA KALIMA/KIMBAYA	
ESQ 01N	UE 6



KIT DE 2 ESCUADRAS DE ALINEACIÓN CON GUÍA HOJA KALIMA/KIMBAYA	
ESQ 02N	UE 2



TOPES PARA HOJAS KALIMA/KIMBAYA	
TOP 001	UE 20

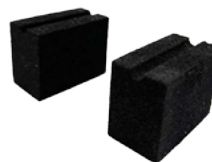

ESPUMA TAPA GUÍA SUPERIOR/INFERIOR KALIMA/KIMBAYA	
ESP 02H	UE 1



TAPA Y TAPETA PORTA ESPONJA SUPERIOR E INFERIOR KALIMA/KIMBAYA	
TAP 02E	UE 1



TAPA ENTRECIERRE SUPERIOR E INFERIOR KALIMA/KIMBAYA	
TAP 01E	UE 1



KIT HOJA FIJA KALIMA/KIMBAYA	
PCI 01F	UE 1

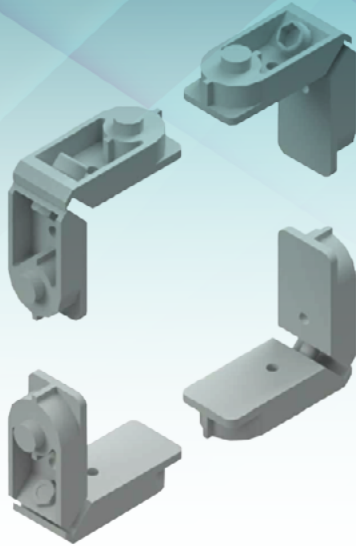

ESCUADRA ENSAMBLE MARCO/HOJA KALIMA/KIMBAYA/ MARCO INFERIOR AWA	
ESQ 01E	UE 1

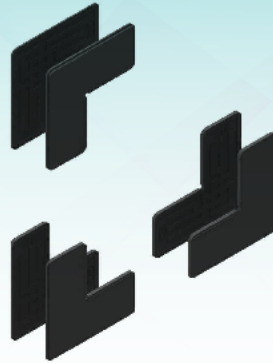

KIT DE 6 ESCUADRAS DE ALINEACIÓN HOJA KALIMA/KIMBAYA	
ESQ 01N	UE 6



KIT DE 2 ESCUADRAS DE ALINEACIÓN CON GUÍA HOJA KALIMA/KIMBAYA	
ESQ 02N	UE 2



TOPES PARA HOJAS KALIMA/KIMBAYA	
TOP 001	UE 20

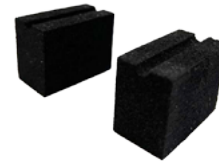

ESPUMA TAPA GUÍA SUPERIOR/INFERIOR KALIMA/KIMBAYA	
ESP 02H	UE 1



TAPA Y TAPETA PORTA ESPONJA SUPERIOR E INFERIOR KALIMA/KIMBAYA	
TAP 02E	UE 1



TAPA ENTRECIERRE SUPERIOR E INFERIOR KALIMA/KIMBAYA	
TAP 01E	UE 1



RODAMIENTO SIMPLE EN AGUJAS 100 KILOS KIMBAYA	
RDA 101-A	UE 1



RODAMIENTO DOBLE EN AGUJAS 200 KILOS KIMBAYA	
RDA 201-A	UE 1

ACCESORIOS



KIT PUNTO DE CIERRE KALIMA/KIMBAYA	
PCI 001	UE 1



KIT MANIJA BIDIRECCIONAL CON TRANSMISION KIMBAYA MANGO CUADRADO NEGRA	
KIT MAN 15F-3	UE 1



KIT MANIJA BIDIRECCIONAL CON TRANSMISION KIMBAYA MANGO CUADRADO NEGRA CON LLAVE	
KIT MAN 15K-3	UE 1

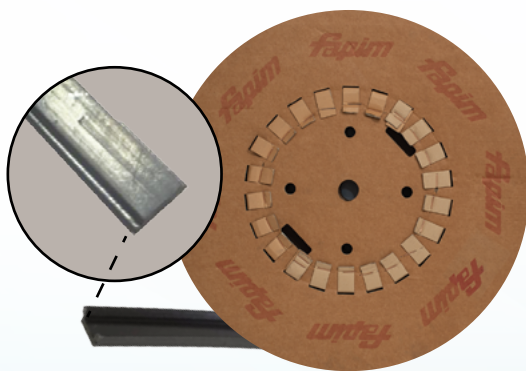

PLETINA DE POLIAMIDA NEGRA SIDERAL/EURO	
POL 02F	UE 250M



EMPAQUE BURBUJA SELLO X 250M NAVE KALIMA/KIMBAYA	
EMB 001	UE 250M

EMPAQUES



EMPAQUE U PARA VIDRIO DE 6 MM KALIMA/KIMBAYA
EMK 06N



EMPAQUE U PARA VIDRIO DE 8 MM KALIMA/KIMBAYA
EMK 08N



EMPAQUE U PARA VIDRIO DE 10 MM KALIMA/KIMBAYA
EMK 10N



KIT 25 CALZA VIDRIO DE 24X10X50 MM HOJA TAIRONA/ZINU/KALIMA/KIMBAYA
KLZ 2410



EMPAQUE DE CUÑA PRESIÓN		
REF.	ESPESOR	VIDRIO
EMC 06N	4 MM	6 / 3+3
EMC 07N	3 MM	9 -10 / 5+4 - 5+5
EMC 08N	5 MM	8 / 4+4
EMC 09N	2 MM	12
EMC 10N	1,5 MM	6+6

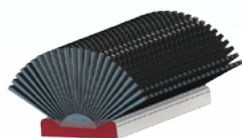

FELPA BASE 5.00 X ALTURA 7.00 MM
FEL 007

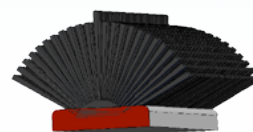

FELPA BASE 5.00 X ALTURA 7.00 MM CON PLASTIFILM CENTRAL
FEL 007P

APLICACIÓN EMPAQUES

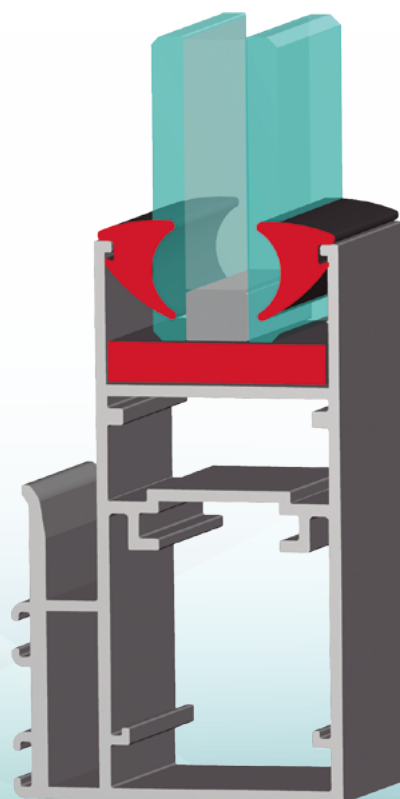
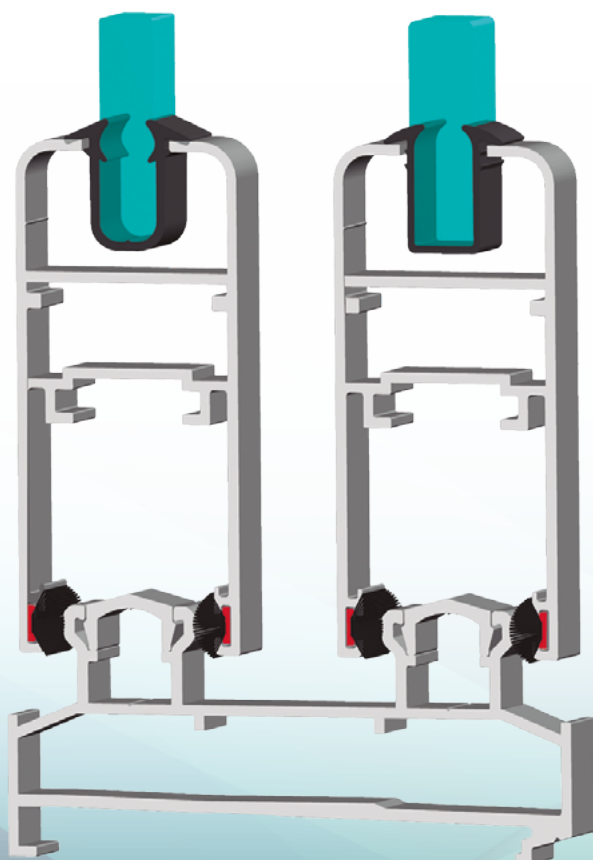

MAQUINARIA Y EQUIPO

PRENSA MANUAL DE
CREMALLERA SIN PEDESTAL
PREN 02S



PEDESTAL DE ANCLAJE
PARA PRENSA CREMALLERA
PED 03A

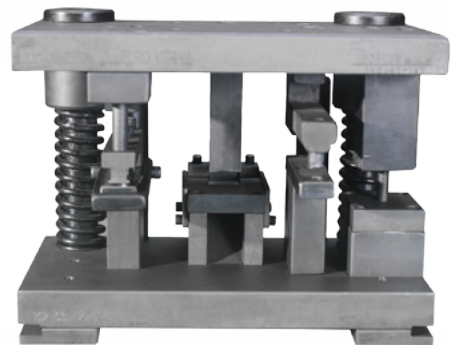

PUNZÓN 4 ESTACIONES EUROVITRAL
PUN EUR4



vital.com.co/catalogos



Vitracol



Vital Bogotá

Cra 52 No. 79-20

Tel: (57) 601 311 6400



Cel: (57) 317 401 8367

317 401 8322

310 230 7356

317 401 8340

Línea Universal y EuroVital

311 526 7502



Vital Cali

Cll 25 No. 5-44

Tel: (57) 602 882 2694



Cel: (57) 317 432 6909

313 765 5651

Línea Universal y EuroVital

317 511 4838